

FAG

QJ234-N2-MPA

Four-point contact bearing

Schaeffler ID:
0167423620000Four point contact bearing QJ2..-N2-MPA,
holding grooves, solid brass cage

Technical information

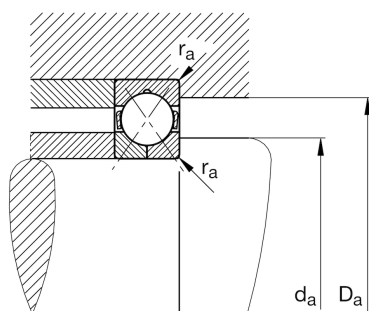
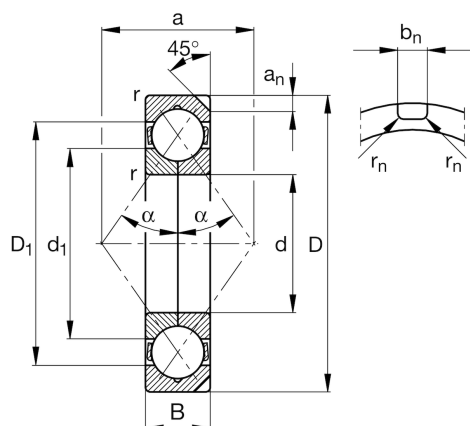

Main Dimensions & Performance Data

d	170 mm	Bore diameter
D	310 mm	Outside diameter
B	52 mm	Width
C _r	420.000 N	Basic dynamic load rating, radial
C _{0r}	630.000 N	Basic static load rating, radial
C _{ur}	23.500 N	Fatigue load limit, radial
n _G	3.750 1/min	Limiting speed
n _{gr}	2.010 1/min	Reference speed
	18,7 kg	Weight

Dimensions

r _{min}	4 mm	Minimum chamfer dimension
D ₁	260,5 mm	Shoulder diameter outer ring
d ₁	221,5 mm	Shoulder diameter inner ring
a	168 mm	Distance between the apexes of the pressure cones
a _n	12,7 mm	Height retaining slot
b _n	10,5 mm	Width retaining slot
r _n	2 mm	Radius retaining slot
	45 °	Angle retaining slot
α	35 °	Contact angle

Mounting dimensions

d _{a min}	187 mm	Minimum diameter shaft shoulder
D _{a max}	293 mm	Maximum diameter of housing shoulder
r _{a max}	3 mm	Maximum fillet radius

Temperature range

T _{min}	-30 °C	Operating temperature min.
T _{max}	200 °C	Operating temperature max.